

Aquacell NG - Connection adapter	
Version	1
Date of first version	2020-06-08
Date of modification	2020-06-08
Modified by	.
Remarks	

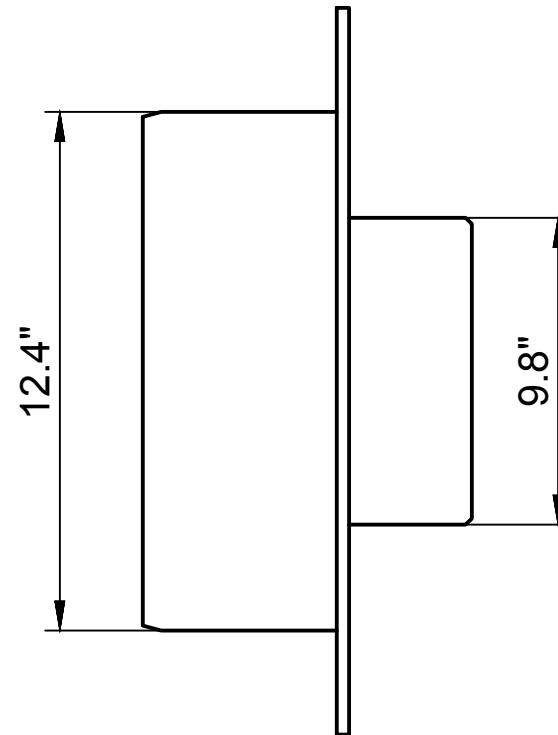

Aquacell NG - Top adapter	
Version	1
Date of first version	2020-06-08
Date of modification	2020-06-16
Modified by	.
Remarks	

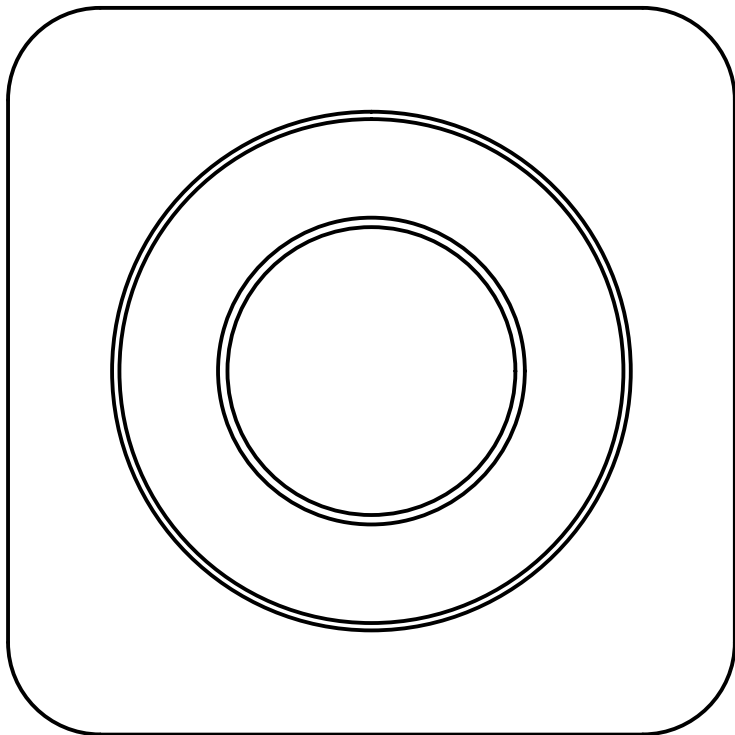
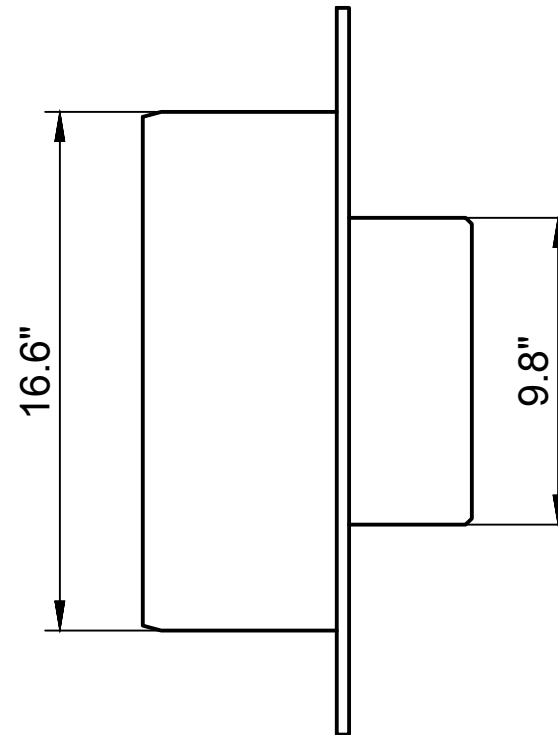
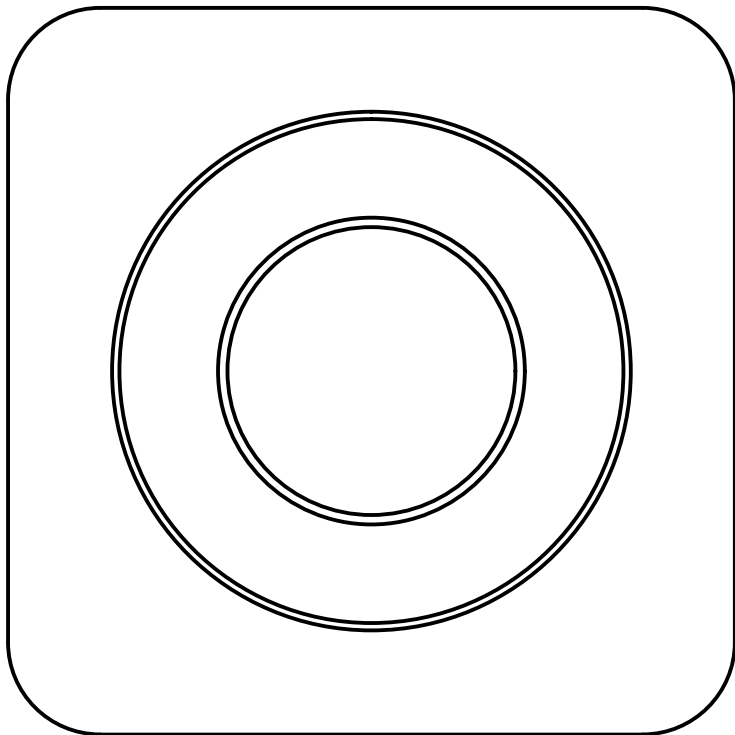

Aquacell NG - Top adapter	
Version	1
Date of first version	2020-06-08
Date of modification	2020-06-16
Modified by	.
Remarks	

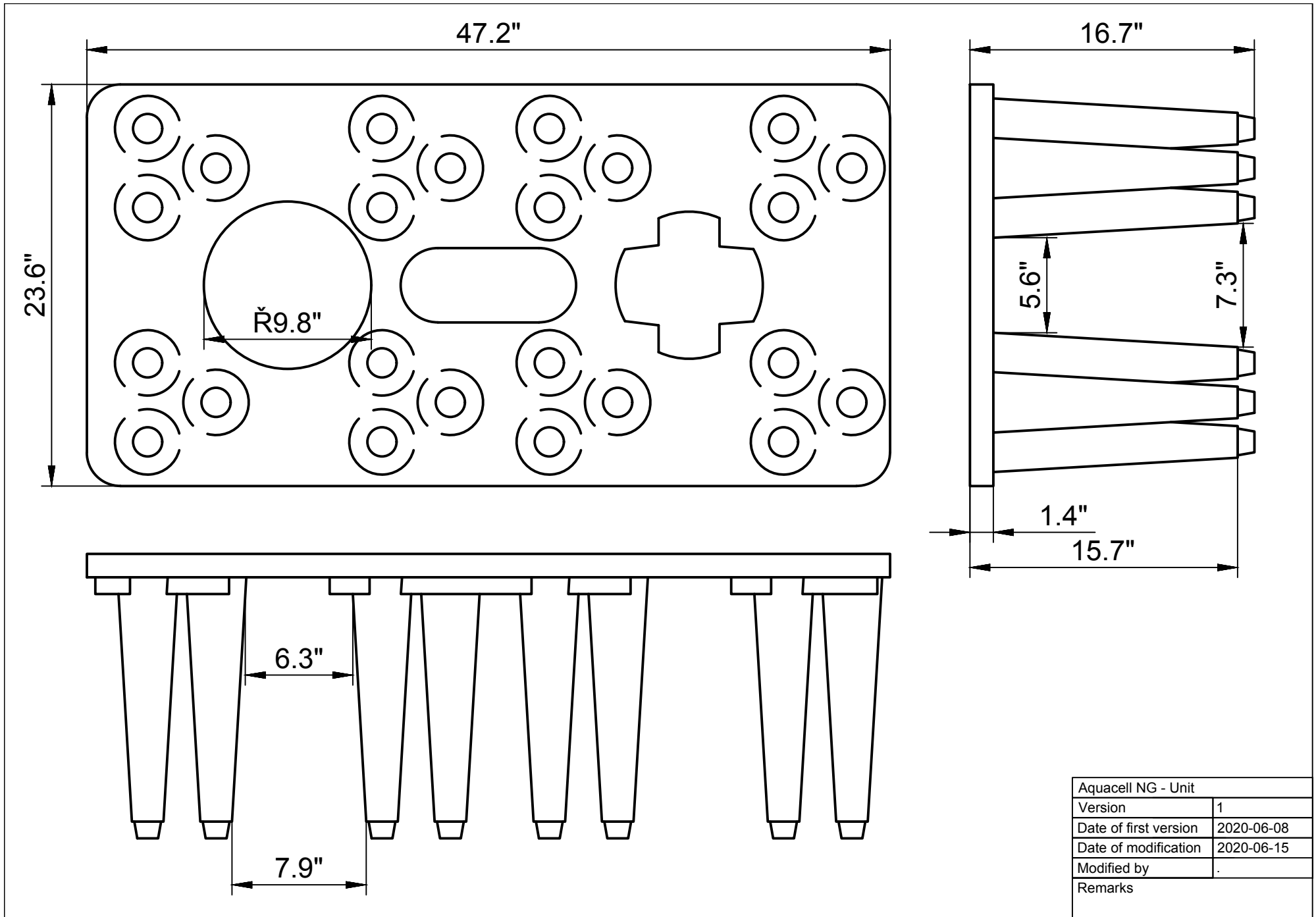

Aquacell NG - Unit	
Version	1
Date of first version	2020-06-08
Date of modification	2020-06-15
Modified by	.
Remarks	

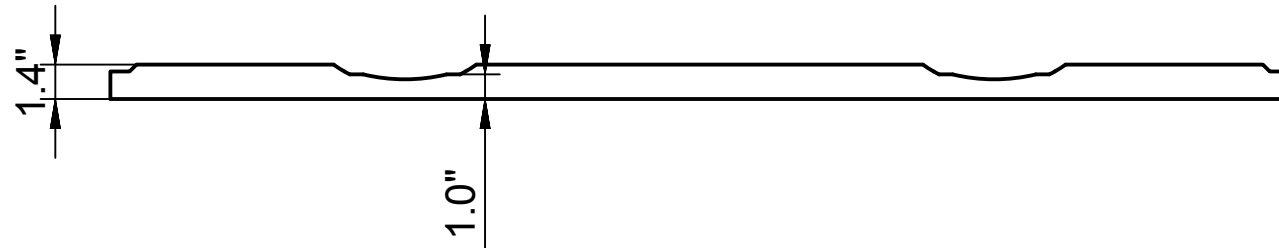
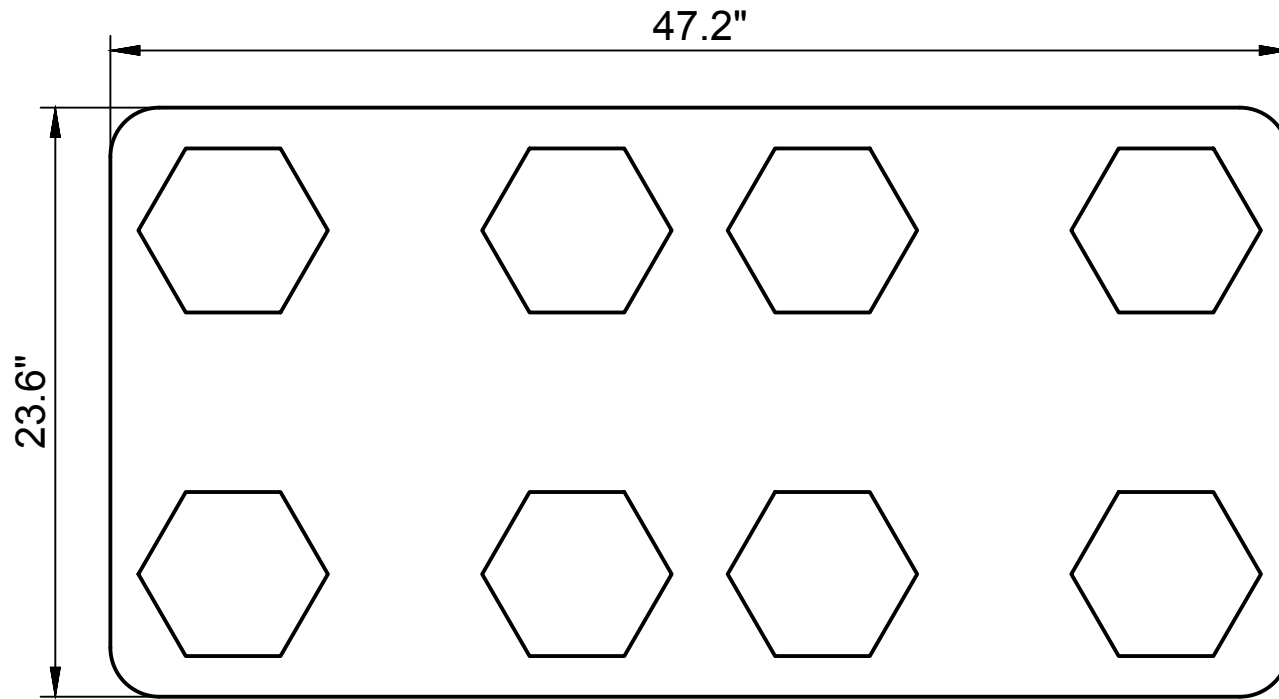

Aquacell NG - Bottom plate	
Version	1
Date of first version	2020-06-08
Date of modification	2020-06-17
Modified by	.
Remarks	

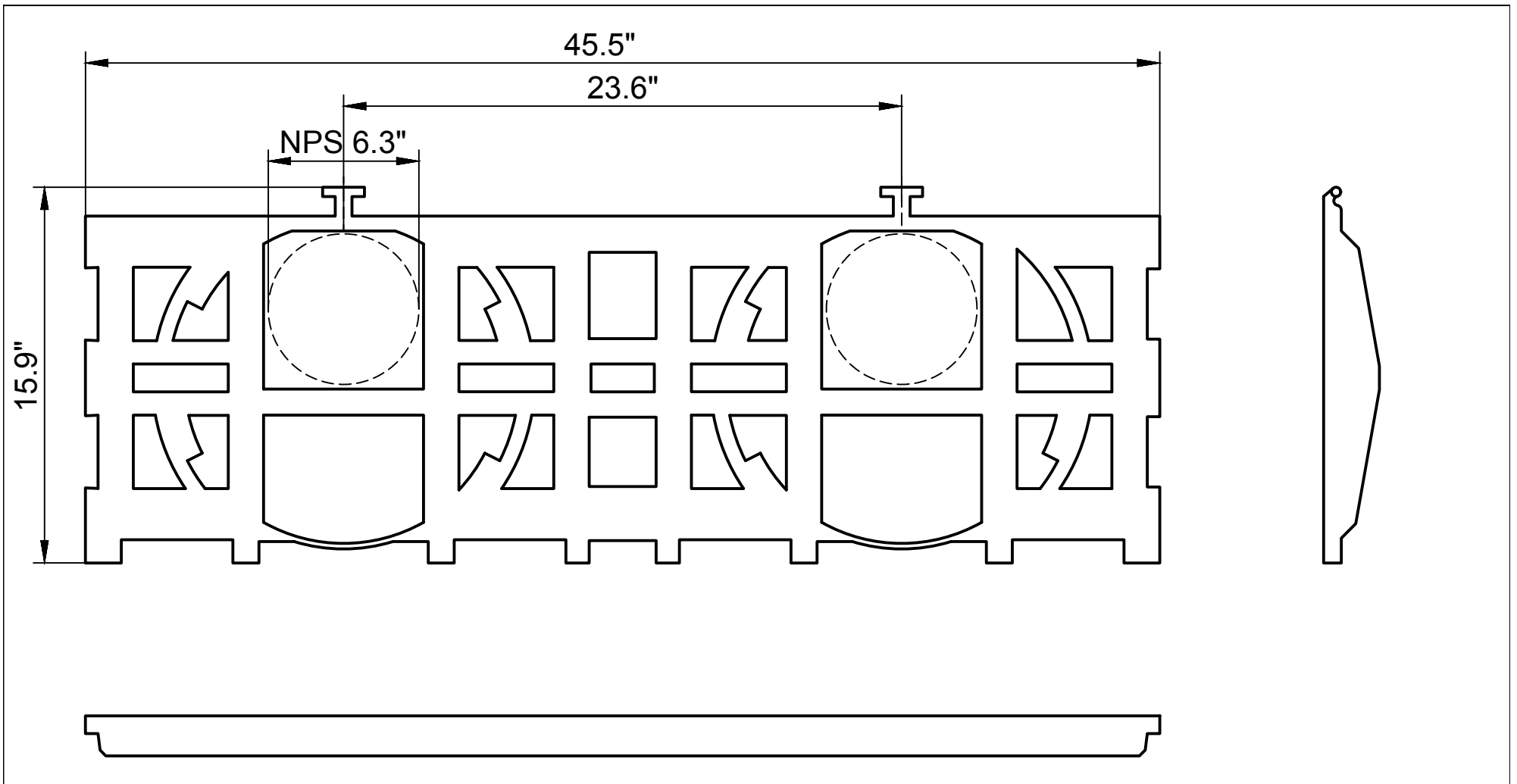

Aquacell NG - Side plate	
Version	1
Date of first version	2020-06-08
Date of modification	2020-06-15
Modified by	.
Remarks	